



Ⓜ Installation, operating and maintenance instructions



The SKG-certified types:

-  type 3 and type 11
-  type 3, faceplate F 24, for timber doors
-  type 11 for aluminium doors

For PVCu doors with a clearance of 12 mm at a faceplate length of 2170/2405 mm.
For other door types as well as varying faceplate length please follow these instructions accordingly.
In case of any queries please contact FUHR.

Locking function

- External:** The locking and unlocking action is carried out by means of a double turn of the key. The latch is retracted via the transmission mechanism with the cylinder key.
- Internal:** See external, the latch can also be retracted by using the lever.

Maintenance

We would like to point out to owners and users of buildings that safety-relevant hardware should be checked annually for wear and tear and a continuous firm fit. Depending on requirement fixing screws have to be tightened or the damaged or worn parts exchanged for original parts by an authorized specialist.

Owners and users of buildings are furthermore advised that the following maintenance work has to be carried out at least once a year:

- All movable parts and locking parts have to be oiled and their working order checked.
- Only cleaning and care products that do not affect the hardware's anti-corrosion qualities must be used.

IMPORTANT: The points outlined above are intended as an addition to the FUHR product information M3/3 from the catalogue "Sicherheitssysteme für Türen, Fenster und Tore" - also shown on www.fuhr.de. Owners and maintenance building managers are instructed to comply with. In the event of non-compliance with these necessary instructions faultless operation of the locks cannot be guaranteed.

GB Installation instructions

- For PVCu doors: Comply with 12 mm continuous and even rebate clearance.
- For timber doors: Comply with 4 mm continuous and even rebate clearance.
- Door leaves and frame must run in parallel throughout the entire height.
- Mortise for the lock cases as per drawing.
- Mortise for the profile cylinder and lever must be in alignment.
- Never drill the fitting when the lock has been installed.
- All contamination such as shavings as a result of drilling must be removed prior to the installation of the lock.
- Attach faceplate with screws of a 4 mm diameter and a length matching the profile system.
- Fixing screws have to be positioned perpendicular to the faceplate.
- Observe exact position of the strike plates as per drawing.
- For SKG-certified PVCu doors: Connect strike plates to the reinforcing profile with at least the rear screws (\varnothing 4 mm).
- For SKG-certified aluminium doors: Attach faceplate with the aluminium profile with screws of a 4 mm diameter, length matching to the profile system. Attach strike plates with screws of a 4 mm diameter through two chambers of the aluminium profile.
- For SKG-certified timber doors: Attach faceplate and strike plates with screws of a 4 mm diameter and 40 mm in length.
- Remove the cylinder's transport protection device only directly before installation.
- Do not use force in the event of tightness or sluggish operation after the lock has been installed! The cause of the problem should be ascertained and remedied instead.
- Suitable protection must be applied to the door leaves during transportation even if the locks are bolted.

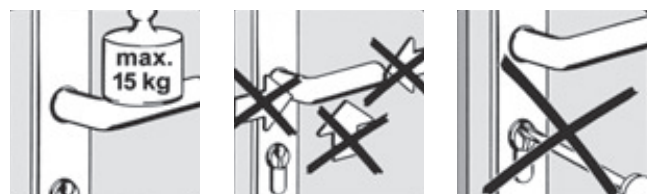
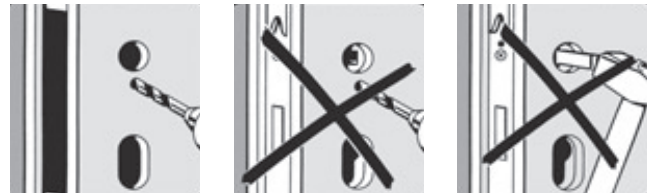

D **GB** Montagehinweise/Installation notes

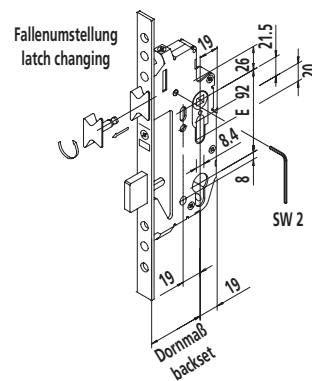
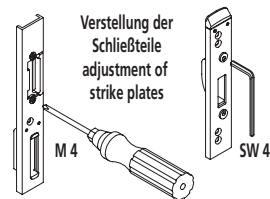
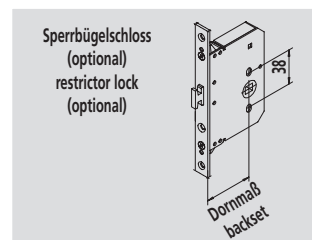
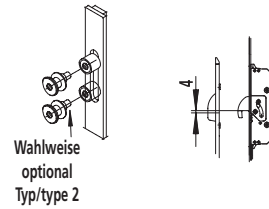
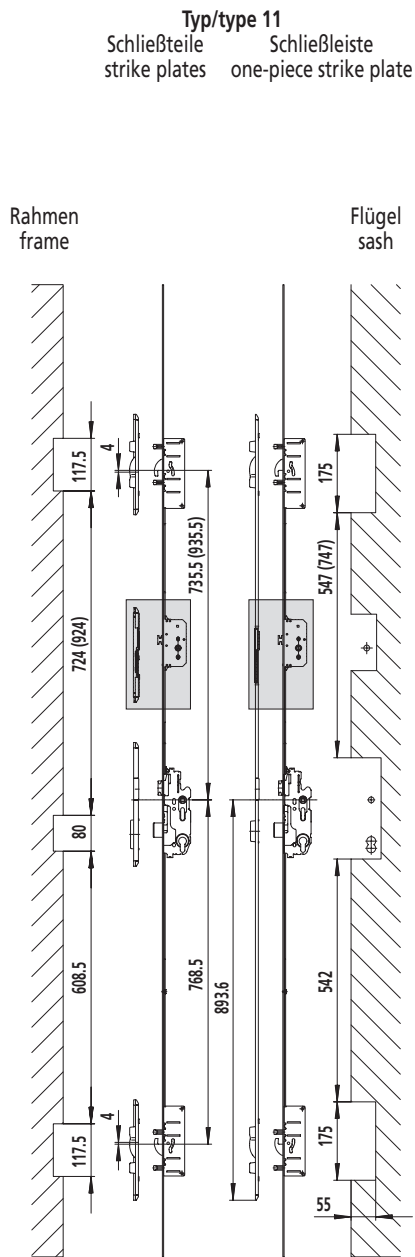

In Klammern gesetzte Maße für Stulplänge 2405 mm.
The dimensions for a faceplate length of 2405 mm are stated in brackets.